

PHOENICIAN REMAINS FROM GIBRALTAR

BY WILLIAM CULICAN

Colin MacLaurin combines many interests: Biblical and Semitic studies, archaeology, farming and politics, scholar in some, gentleman in all. Lately he has taken great interest in the archaeology of the Phoenicians in the West Mediterranean and has put a site or two on the Phoenician map. In putting together, however unsatisfactorily, material for yet another site, I am aware of the way his keen interest in archaeology has helped provide a broader niche for this subject in the Australian universities.

Gorham's Cave on the southeast side of the Rock of Gibraltar is known to archaeologists through the excavations of Palaeolithic flint implements published by Dr. J. Waechter, *Proceedings of the Prehistoric Society*, XVII (1951), p. 83 ff. In the uppermost stratum of the cave deposit a small amount of Punic pottery of common types was found together with fragments of two terracotta figures and some typical glassware. There were found in addition a number of scarab seals, which are the main topic of this article. A short description of the pottery will be added, and, for a completer record, photographs of pieces in the British Museum noted by R. D. Barnett, *B.M.Q.* XXVII, 3-4, 1963. These also come from Waechter's excavations.

The scarabs are almost all poorly executed and badly worn. On certain examples it has not been possible to make out the signs. On no. xviii the markings appear to be derived from the hieroglyph forms of no. xvii, but are so careless and summary that it is doubtful whether they were ever intended to be meaningful marks. A few examples with blank or erased surfaces have been omitted: their materials add nothing to the range described here. The difficulties of obtaining adequate photographic illustration have made it preferable to present drawings of most examples. These are made by a conflation of the details of the scarab faces in two different sets of photographs of the seal impressions taken in different lights. It appeared preferable in a few cases, where even this method failed to provide an absolutely definite shape, to employ a little interpretation of indications given: these cases are noted in the description. Dotted lines indicate areas of damage.

The reverses of the scarabs have not been drawn, but a conspectus of types is given in Figs. 2, 4 and 5 where it will be seen

that the paste examples have two small triangles cut into the elytra where it joins the thorax, a feature noted in the scarabs at the shrine of Limenia at Perachora (H. James in T. J. Dunbabin, *Perachora, II*, p. 466 ff) and at Marsiliana d'Albegna, F. W. von Bissing, *Studi Etruschi*, VI, 1931, p. 328, VIII, 1933, p. 375. This old device of the XVIII Dynasty was revived on scarabs of the XXVIth, as A. Rowe, *Catal. Egyptian Scarabs, etc., in the Palestine Arch. Mus.* 1936, types 123, 125.

A. SCARABS WITH HIEROGLYPHIC SIGNS (Sign numbers from Sir A. Gardiner, *Egyptian Grammar*, 3rd ed. 1957.)

- (i) Gibraltar Mus. Blue Paste. Max. diam. 13 mm. Figs. I, i; 2, i. *Ra?—user—maat—user—nfr* (signs H6; maat; H6; F35). Cp. W. M. F. Petrie, *Historical Scarabs*, sheet 66, of Dyn. XXV. Scarabs incorporating maat with other signs, Perachora nos. 633-4; 642-3, but combination is not the same.
- (ii) Ashmolean Mus. 1964. 394. White paste. Max. diam. 14mm. Figs. I, ii; 2, ii. *Ra—user—maat—?* (signs N5; H6; maat; N27) the final sign may be mistaken nor *nb*, cp. Petrie, *op. cit.*, sheet 47, T.171, scarabs of Rameses II; but other interpretations are possible particularly that of arms stretching to the sun, as on scarabs of Hatshepsut.

Two scarabs similar to i and ii have been found at Carthage, A. Delaporte, *Catal. des cylindres orientaux*, I, 1920, gamma 12 and 17, pl. 59, 39 and 44; and we can see the distribution of similar scarabs at two points: Poggio alla Guardia at Vetulonia, *NdS*, 1898 p. 93, fig. 7, also W. von Bissing, *Studi Etruschi*, V, 1931, no. 30 and *ibid.*, VIII, 1933, p. 375 no. 14: Layard, *Discoveries of Nineveh and Babylon*, p. 281, nos. 5 and 7 — all examples in white schist or paste. At Utica there is a relative, Cintas, 'Deux campagnes de recherches à Utique', *Karthago*, II, 1951 fig. 22.

- (iii) Ashmolean Mus. 1964, 397. White paste. Max. diam. 12mm. Fig. I, iii. Top broken away. Signs: H6; BI; I 12. Cp. Newberry, *Scarabs*, 36975.
- (iv) Gibraltar Mus. Dark green paste. Max. diam. 11 mm. Figs. I, iv; 2, iv. Signs: G17; 039; S29; V 13; V 30. Personal name *Psmtk* of Psammetichos I. The second sign poorly rendered but the rest clear. Cp. W. M. F. Petrie, *Scarabs and Cylinders with Names*, pl. LV, no. 31; Hall, *Catal. Egyptian Scarabs in Brit. Mus.* 2513-2518; P. Newberry, *Scarab-shaped Seals* (Catal. gén. du Mus. du Caire), nos. 36302-36305, 36308. A few scarabs of this same type have been

found at Carthage, Vercoutter, *op. cit.*, nos. 1, 2, 510, 511, 512, pp. 56-57. Vercoutter's suggestion that the type may also designate Psammetichos III appears to have little support (see below).

- (v) Gibraltar Mus. Max. diam. 12 mm. Figs. I, v; 2, v. White paste. Signs: G36; I 12; F44. A detail links with a scarab from Tharros, where the hawk has the same oblique bars on the back of the wings, A. della Marmora, *Sopra alcune antichità sarde*, pl. A4, which I have checked against the original in Cagliari Mus.
- (vi) Gibraltar Mus. Max. diam. 13 mm. Figs. I, vi; 2, vi. White Paste. Signs: N 10; G 36. Rather similar: A. Merlin and L. Drappier, *Nécropole punique d'Ard el-Kheraib*, p. 71, fig. 46.
- (vii) Ashmolean Mus. 1964. 400. Max. diam. 8 mm. Fig. I, vii. Brown paste. Signs: N 10, I 12.
- (viii) Gibraltar Mus. diam. 11 mm. Fig. I, viii. White paste. Signs: V30; H6; F35; V30.
Cf. Vercoutter, *op. cit.*, p. 62 for this combination on seals from Carthage. There is a closely comparable seal from Tharros, Elena, *Scavi nella necropoli occidentale di Cagliari* p. 85, fig. I. According to Petrie, *HS* sheet 66 (B.M. 4219) the design was current in the XXV Dyn. Closely similar scarab from Nimrud: H. A. Layard, *Discoveries of Nineveh and Babylon*, p. 281, no. 5, white paste?
- (ix) Ashmolean Mus. 1964. 391. Pale blue paste. Max. diam. 9 mm. Fig. I, ix. Signs: H6; D 12; Y5; S29. Ki-men-ra?
- (x) Gibraltar Mus. Max. diam. 10 mm. Fig. I, x. White paste. Signs: F35; U33; N32?; ? ; V30.
- (xi) Ashmolean Mus. 1964. 401. Max. diam. 9 mm. Fig. I, xi. Dark green paste. Signs: F35; I 12. These signs placed upon *nb* are found on early white paste scarabs at Carthage, cf. Vercoutter, *op. cit.*, 111, 112, the latter dated to the seventh century from the general context of the Dermech necropolis, R. P. (A) Delattre, *Nécr. punique de Douimès*, 1893, p. 7, fig. 13b. Cp. *Perachora* II, p. 488, no. 192. For analogies to this scarab type, P. Elena, *op. cit.*, p. 86, nos. 8 and 9.
- (xii) Ashmolean Mus. 1964. 399. Dark green paste. Max. diam. 11 mm. Fig. I, xii. Signs: ?; S42; H6; I 12. Personal name I-ti-neb?
- (xiii) Gibraltar Mus. Max. diam. 14 mm. Fig. I, xiii; 2, xiii. White paste. Signs: D37/38; I 12; N33; Y5.

- (xiv) Ashmolean Mus. 1964. 402. Dark green paste. Max. diam. 9 mm. Fig. I, xiv. Signs: F35; H6; I 12. For similar combination see C. Blinkenberg, *Lindos, les petits objets*, no. 1534.
- (xv) Gibraltar Mus. Max. diam. 15 mm. Figs. I, xv; 2, xv. White composition. Centre motif: *kheper* beetle flanked by two uraei. Above: orb with drooping wings: two curled uraei hang from the orb. Below: *nb* sign or arc. Traces of a thin raised border. Cp. Vercoutter, *op. cit.*, no. 579, from the Odéon-Théâtre graveyard at Carthage and dated by the author to the fourth century B.C. This latter example is, however, of jasper and has additional engraved details (the disc-and-crescent and star) in the background which suggest that it is Phoenician work. The Gibraltar example is probably considerably earlier.

B. SCARABS WITH FIGURES

- (xvi) Gibraltar Mus. Max. diam. 16 mm. Figs. I, xvi; 2, xvi. Beautifully made scarab of dark bluish green glass, well cut. The engraving shows a kneeling figure, probably a version of the Egyptian god Sebekh between papyrus stems and supporting the solar barque. The design is surrounded by a notched border. This type is not included amongst scarabs from Carthage, but it is of a type current in the Punic sphere and there are some imprints of it on clay sealings from Selinunte which most probably belonged to a library of papyrus documents there: A. Salinas, 'Sigilli di creta rinvenuti a Selinunte', *Not. d. Scavi* 1883. On this example the orb within the solar barque has a horizontal topping which makes it appear bottle-shaped. Cp. also Vives, *La necrópoli de Ibiza*, 1917, pl. XXII, 20.
- (xvii) Gibraltar Mus. Max. diam. 18 mm. Figs. I, xvii; 2, xvii. White paste. Shoul or Sebek holding aloft the solar boat. She kneels on the *nub* (S 12) sign and between notched stems. Cp. glazed steatite example of XIX-XX Dyn. Newberry, *Scarab-shaped Seals*, 36648. Cp. F. L. Griffith, 'Oxford Excavations in Nubia', *LAAA*, X, pl. XLV, 3.
- (xviii) Gibraltar Mus. White paste. Max. diam. 12 mm. Fig. I, xviii. The signs are an illegible jumble: possibly 'Petosiris' is intended, or 'Petabastet' attested on a scarab of Dyn. XXIII, Hall, *Catal. Egyptian Scarabs, etc., in Brit. Mus.*, no. 2475.

- (xix) Green paste. Max. diam. 13 mm. Fig. 3, xix. Sphinx with raised wings and raised tail sitting on an arc-shaped exergue. Slight traces of cross hatching on body and wings. The sphinx apparently wears a conical head-dress. This type is known at Naucratis, W. M. F. Petrie, *Naukratis*, I, 1888, pl. XXXVII, no. 22, and early 6th c. Carthage, Vercoutter, *op. cit.*, pp. 131-133. There is also an example in blue paste from Siculan III grave at Finocchito, *Bull. Pal. Ital.*, 1894 p. 42 f. A good example in brown paste from Beth Shemesh, D. Mackenzie 'Excavations at Ain Shems', *Pal. Explor. Fund Annual*, II, 1912-13, p. 69, pl. XXXVIII, 2.
- (xx) Ashmolean Mus. 1964. 392. Max. diam. 11.2 mm. Dark green paste. Fig. 3, xx. Two schematic figures walking towards a central post. Clearly cut exergue. Scarab broken away at top. Cp. A. Taramelli, *Guida del Museo Naz. di Cagliari* (1914), fig. 67, pl. XXXIX, bottom row, second from left.

6. PHOENICIAN SCARABS

- (xxi) Gibraltar Mus. Green jasper (?). Max. diam. 15 mm. Fig. 3, xxi. Fairly good work depicting a mounted horseman with a rounded head-dress. No other detail of clothing is apparent. One hand is raised against his chest. It is possible that this motif has religious significance, since there is considerable evidence to suggest that one of the Carthaginian deities was represented mounted. Most significant is the seal *Catal. Mus. Lavigerie*, I, pl. XVIII, showing the mounted figure with rounded head-dress under a winged disc. He appears to carry some object over his shoulder, possibly the axe which is carried by figures on Punic seals and razors. H. Fantar has drawn attention to the divine horseman on a terracotta plaque from Carthage, *Africa*, I, p. 19 ff, where the figure is very hellenized and wears a Greek crested helmet. Compare the seals Vercoutter, *op. cit.*, 604, 605, jasper seals of the 4th c., and the terracotta roundel from Ibiza recently discussed by J. M. Blázquez, 'Dios Jinete púnico sobre un Disco de Ibiza', *Zephyrus*, XVII, p. 101 ff. There is a disc at Utica more similar in design to our seal, Cintas, *loc. cit.*, fig. 22.
- (xxii) Gibraltar Mus. a, b (two photographs of impressions). Green jasper scarab. Max. diam. 12 mm. Fig. 3, xxii. Face of Bes schematised by shallow drilled roundels. Notched border. He wears a vestigial crown of three knobbed pins.

The back of the scarab is unworked. The Bes-faces on this and the following seals are paralleled at Carthage in such seals as *Catal. Mus. Lavignerie*, I, pl. XXXIV, no. 44, and Vercoutter, *op. cit.*, no. 542 (Théâtre and St. Monique cemeteries, fourth century). Bes-face scarabs are well represented in Ibiza A. Vives, *op. cit.*, pl. XXV, 20 and pl. XI. J. M. Maná de Angulo, *op. cit.* and D. Carlos Roman, 'Excavaciones en Cala d'Hart', *Memorias*, 21, 1917 (Junta Sup. de Excavaciones y Antiquèdades); and *Antiquèdades ebusitanas*, pl. C5. Doubtless these were used as charms against ill-health, since Bes appears to have been equivalent to Eshmun, the god of healing.

- (xxiii) Ashmolean Mus. Green paste. Max. diam. 13 mm. Fig. 3, xxiii. Face of Bes, crudely drawn. The eyes, nose and mouth can be clearly distinguished, but the lower part of the face is completely covered in hair. There is a large tuft of hair on the head. The back of the seal is unworked.
- (xxiv) Ashmolean Mus. 1964. 386. Max. diam. 12.1 mm. Fig. 3, xxiv. Winged Bes figure embraces or protects a youth (young Osiris?) who turns away his head. The top part of the seal is broken off. Probably from the same workshop as a Tharros seal in the Victoria and Albert Museum, C. Oman, *Catalogue of Finger Rings in the Victoria and Albert Mus.*, pl. I, no. 2, which resembles it in style.
- (xxv) Gibraltar Mus. (two photographs of impressions). Max. diam. 14 mm. Fig. 3, xxv. Green jasper. The head of a negro, notched border. The top of the head is broken off. The motif is common on Greco-Phoenician scarabs, cp. Vives, *op. cit.*, pl. LXVI, 20; also J. M. Blázquez 'Escarabeos de Ibiza', *Zephyrus*, XXI-11, 1970-71, fig. 14. Vercoutter, *op. cit.*, no. 547, 588, 589 (5th-3rd c. B.C.) There is an excellent example in black jasper from Cyprus, *Burlington Fine Art Club Exhibition* 1903, p. 255.
- (xxvi) Ashmolean Mus. Green jasper scarab. Max. diam. 16 mm. Fig. 3, xxvi. Bearded man fights with a rearing animal-lion? His weapon is held behind him. The stance appears to be derived from Achaemenian style. Cp. Vives, *op. cit.*, pl. XXV, 1, 2.
- (xxvii) Ashmolean Mus. White paste. Max. diam. 14 mm. Fig. 3, xxvii. A lily upside down or a schematically drawn fly. There are very close parallels from Tharros, and a discussion by Mansell, *Gazette arch.*, 1887, p. 74 f. Cp. the example illustrated by La Marmora pl. D, 95. The fly or wasp inside a tramline border occurs also on Greek gems of the

4th and 5th c. B.C., G. M. Richter, *Engraved Gems of the Greeks and Etruscans*, 1968, no. 477.

- (xviii) Gibraltar Mus. Green jasper. Max. diam. 15 mm. Fig. 3, xxviii. Athlete with strigil, a Greek type current among the Phoenicians. For Ibiza, D. Carlos Roman, 'Exc. en Cala d' Hart', *Memorias*, 21, 1917 (Junta Sup.), pl. VI, from a 3rd c. context.

In the following scarab seal the motifs are identified only tentatively, since it is badly worn.

- (xxix) Gibraltar Mus. Green jasper. Max. diam. 14 mm., not illustrated. Badly worn image represents an eagle attacking a hare or gazelle from behind. The motif is well attested on green jasper scaraboids at Carthage, Vercoutter, *op. cit.*, nos. 620-622; Sardinia: A. della Marmora, *Sopra alcune antichità sarde*, pl. B, 86, 87. At Ibiza, Blázquez, *loc. cit.*, fig. 21, there is a variant of an eagle pouncing on a serpent. The examples at Carthage appear to date from the 4th c. This motif appears to be confined to Phoenician jasper seals and appears to have had some good-omened meaning in the Ancient Near East. Cp. A. Merlin, L. Drappier, *op. cit.*, p. 41, fig. 15; and *Bull. Arch. Sardo*, I, pl. II, 8.7.

DATE-RANGE

Since the scarab relating to Rameses II (no. ii) is a late and probably 'Naucratic' production, discussion of dating must begin with the Psammetichos scarab (no. iv).¹ All published scarabs with this hieroglyphic spelling are taken to relate to Psammetichos I, but it is equally possible that some of these could relate to Psammetichos III. We could not therefore accept any date higher than 580 B.C. for the production of such a scarab, and indeed it might have been in circulation considerably later than the reign of Psammetichos III. It must be borne in mind, however, that the only case where the context of the many Psammetichos scarabs can be checked, Grave 214 at Dermech, P. Gauckler, *Nécropoles puniques de Carthage*, p. 94 and pl. LXVV (=Vercoutter, *op. cit.* no. 2), the grave appears to be of the late 7th or early 6th c.:

1. On the occurrence of archaizing and 'revived' scarab types on Punic sites see Vercoutter, *op. cit.* For a chance find of a scarab of Tuthmosis III at Lixus, see *Orientalia*, 24, 1955, p. 132, pl. XXXVI; for scarabs of Amenophis III at Tharros, Schiaparelli, *Not. d. Scavi*, 1886, p. 123-6; a seal of Sebekhotep (Dyn. XIII) from a Punic tomb on Malta, M. Murray, *Ancient Egypt*, 1928, p. 50. There are scarabs of Amenophis III and Tuthmosis III from Ibiza in Barcelona Mus., S. Quintina, *Sefarad*, VI, 1945, pp. 125-128.

it contains a Corinthian amphoriskos of type in H. Payne, *Necrocorinthia*, p. 314, no. 1073 A ff. Vercoutter wrongly ascribes it to the fifth century. Several scarabs of Psammetichos have been found in Ibiza (cf. the excellent example illustrated by J. M. Maná de Angulo, *Guia del Mus. Arq. de Ibiza*, 1957, pl. XI, top row centre) but the contexts are not known. Since the Psammetichos scarabs at Carthage most likely date to the late 7th c. and since Ibiza was founded, according to Justin, in 650, there is no reason why the Psammetichos seals at both sites cannot be contemporary. A seal of Psammetichos I was found at Alcacerdo-Sal in Portugal in an uncertain context,² but apparently underlying the Hallstatt II cemetery on the site. It was found in one of a group of cremation burials which are undoubtedly Phoenician. These are poorly published, but to judge from the photographs of the pottery published by M. de Lourdes Costa Arthur, *II°* good claim can be made that these burials are indeed of the 7th *Congreso Arqueologico Nacional*, Zaragoza 1952, p. 369 ff, a c. B.C. The lamps of heavy red-slipped and burnished pottery correspond to those of Carmona, Mogador and Almunécar.

A number of sites in the Mediterranean, including Spain, have yielded scarabs with hieroglyphs or Egyptian design; the problem of their origin has been most recently discussed by James (*loc. cit.*) and for Carthage by J. Vercoutter, *Objets égyptiens et égyptisants du mobilier funéraire carthaginois*, 1954. No group has much comparison with Gibraltar pieces, though there are one or two scattered analogies. We should, however, be quite clear about one point in the discussion of scarab origins. Von Bissing argued in his paper on the Conca scarabs, F. von Bissing, 'Rapporti commerciali della colonia greca in Egitto, Naukratis', *Congresso Internaz. di Preistoria e Protohistoria Mediterranea, Atti*, Florence 1950, pp. 479-482, that these and others in Italy could not have come from Naukratis, since they occurred in Western contexts before the foundation of Naukratis in 610 B.C. The same is true of the group of scarabs from Ischia discussed by S. Bosticco, 'Scarabei egiziani, etc.' *La Parola del Passato*, LIV, 1957, pp. 215-229, which includes a Bocchoris scarab. The fact remains, however, that certain scarabs found in quantities in Naukratis and Rhodes do occur in far Western contexts, like those from Can Canyis in Catalonia (see below). These have the characteristic design of a duck, goose, goat or other animal with a circle above their backs, or occasionally a marching

2. The best available published photograph of this scarab seal is in P. Bosch-Gimpera, *Etimologia de la Peninsula Ibérica*, fig. 216. The 7th c. date of this seal is accepted by A. García Bellido, *Fenicios y Cartagineses en Occidente*, 1943, p. 76.

slender sphinx. There is every reason to suppose that these did originate in Naucratis, since they are especially common in Rhodes and occur together with Naucratic pottery at Kato Phana in Chios, *BSA* XXXV, pp. 163-4, pl. 32. They make their initial appearance later in the West than hieroglyphic scarabs like those in seventh century contexts in Spain.³

But the obvious source of the multitude of pre- and non-Naucratic scarabs in the Aegean and Punic west was Memphis, where by long tradition foreign merchants had settled and where Herodotus found the cantonments of Greeks and Phoenicians established.



A. Drawings of scarabs from Mit-Rahineh (Memphis) from Eckley B. Coxe Expedition Notebooks.

Scarabs from Memphis are not abundantly published and I reproduce here (text fig. A) the drawing of scarabs from the XXII-XXV Dynasty levels of Mit-Rahineh in Memphis from the notebooks of the Eckley Coxe Expedition preserved in the University

3. Hieroglyphic scarabs without personal names come from early 'Palaeopunic' tombs at Malaga, A. Arribas and J. Wilkins, *La Necrópolis fenicia del Cortijo de las Sombras* (Granada, 1971), p. 206, fig. 8; M. Pellicer, *Excavaciones la Necrópolis púnica 'Laurita' del Cerro de San Cristóbal* (Madrid, 1962), pp. 62-3, figs. 9, 24, 34. Another example of an early context is Bonsor, *CAVB*, p. 80, fig. 89, now in the Hispanic Soc. Museum, New York, of white steatite, not gold as sometimes stated in Spanish references.

of Pennsylvania Museum. White paste and steatite scarabs were common and their designs have many points of comparison with the white paste group from Gibraltar. Brown and blue paste scarabs are recorded from Memphis, but in these materials poorly cut scarabs were already current in Palestinian sites by 700 B.C. (Beth Shemesh particularly, D. Mackenzie 'The Tombs at Beth Shemesh' *Palestine Expl. Fund Annual* 1912-13, pl. XXIXB). The earliest dated scarabs in the West are those from Ischia some of which were mounted in silver rings of Phoenician type and for which the maximal date-range is 750-675 B.C. It will be noted that the elytra of examples published by G. Buchner, *Greci e Italici in Magna Graecia: Atti del I° Convegno sulla Magna Graecia* (Taranto 1961), p. 256 with plate, are close to the white paste group (Fig. 4) from Gibraltar. One scarab, S. Bosticco, *loc. cit.*, no. 476, fig. 23 (white steatite) is virtually identical with our no. ii.

Next, there is a general likeness to the designs of the scarabs found in the tombs of the orientalisising period at Pontecagnano, published by G. D'Henry, 'Tombe orientalizzanti in Contrada S. Antonio' *Not. d. Scavi*, 22, 1968, pp. 83-4, fig. 6. These are of white paste, executed in large bold signs, badly cut, and to be dated to the end of the seventh century.

It must also be pointed out that nos. xv, xvi, xvii, from Gorham's Cave, albeit poor in execution, have genuine Egyptian motifs of a type not attested at Perachora or on other Naucratic or Rhodian scarabs. The argument of Vercouter that Rhodian trade brought Naucratic and Rhodian objects, including scarabs, to Carthage has only the support of a few faience objects at Carthage of "Camirus faience," which may or may not have been made on Rhodes. But we cannot presume that Rhodian trade brought scarabs to Ibiza, since no objects of possible Rhodian origin have been found there. There is just as much likelihood that the Phoenicians at Memphis made and traded them.

It is my opinion therefore that the scarabs from Gorham's cave largely represent XXVI Dynasty non-Naucratite types and are to be placed in the sixth-seventh centuries B.C. None needs be later than 550 B.C. The Phoenician seals are later, belonging to the fifth and sixth centuries B.C.

Scarabs appear to have reached Spanish sites by way of Punic trade mostly in the fifth-fourth centuries. White paste scarabs with hieroglyphic signs are reported by M. Astruc, *La Necrópolis de Villaricos* (Informes y Memorias 25, 1951), pl. XX, 18, but the drawings are poor and cannot be used. A white paste scarab from El Molar, Alicante, is illustrated by J. J. Senent Ibanez,

Memorias 107, 1929 (Junta Sup. de Excavaciones y Antigüedades) p. 15 pl. XVII, 3, from a fourth century context. The cut of the face and of the elytra is comparable to examples from Gorham's Cave cp. Fig. 2 bottom row, right.

Two groups of scarabs from more northerly coastal sites have earlier contexts. The group published by S. Vilaseca *et al.*, *La Necrópolis de Can Canyis* (Trabajos de Preistoria VIII, 1963), p. 73, have designs of lions, goats and lying sphinxes, with discs over the back. These, together with examples from Mas de Mossols, J. Maluquer de Motes, 'Los Fenicios en Catalunya' *Tartessos y sus Problemas* (Barcelona 1969), pl. II, may definitely be classed as Naucratis in style, since they occur in Naucratis, Rhodes, etc. Scarabs discovered in Greek sites in S. France are described by F. Benoît, *Recherches sur l'hellénisation du Midi de la Gaule*, p. 68. They appear to be Naucratis except for a green glass paste scarab from Doubs, R. Bernard, *Rev. arch. Est.*, 6, 1955, p. 350 and J. Leclant, *Orientalia* 27, 1958, p. 101.

AMULETS

Fig. 5 shows a few paste amulets, an Egyptian *odjat* eye on the right, a plaque of white paste on the left bearing a fretwork design of the Hathor cow suckling her calf on one side and the Osiris eye on the other (Fig. 1). Similar plaquettes with cows are common at Ibiza, cf. Vives, *op. cit.*, XXXVIII, 16-19 and are also known at Carthage, P. Cintas, *Amulettes puniques*, pl. XVIII, 118-9; P. Gauckler, *Nécropoles puniques de Carthage*, pls. CXXXIX, CLXXVI, CLXXVII; Vercoutter, *op. cit.*, Nos. 887-900, p. 273; *CRAI* 1900, p. 179; *RA*, 1890, p. 14.

At Carthage a stag or a lion is often depicted instead of the cow. Currency in the fourth century at Carthage is shown by examples, Merlin and Drappier, *Ard el-Kheraib*, p. 54. They have been found at Camarina, Selinunte and Megara in Sicily, P. Orsi, *Monumenti Antichi*, I, 1892, col. 939, probably taken there by Carthagian traders. In Egypt, rectangular fretwork plaques of white paste with the Horus eye in fretwork, appear for the first time in the XXV Dynasty. Many examples from the Phoenician coast: A. de Ridder, *Collection de Clercq: Les Bijoux*, 2376-2397; and in Cyprus, E. Gjerstad, *SCE*, IV, 2, fig. 32. They occur at Tharros, A. Crespi, *Catalogo della Raccolta Raimondo Chessa*, pl. 32 and *Annali*, 1883, p. 91. similar to the one from Gibraltar, and *Mon. Ined.* XI, pl. 52, 11-21. Also from Punic tombs in Palermo, *NdS*, 1941, p. 270, fig. 14. Pierced plaques also occur at Mit Rahineh (unpublished) and Naucratis, Petrie, *Naucratis I*, pl. XXXVIII, 17. There is a dated XXVIth Dynasty example with cartouche of Ahmes, Walters Art Gallery, Baltimore, No. 42.377.

PUNIC POTTERY

The Punic pottery found in the Gorham's Cave excavations consists largely of wheel made shallow bowls and dishes. Pieces I was able to examine in Oxford are described here.

HEMISPHERICAL BOWLS, Fig. 7

- A. Hemispherical bowl, base missing, diam. 18.9 cm. Plain rim; clay with small white grits; buff-cream slip with pink stains on the inside. Brown painted stripe on the outer rim and two sets of thin brown lines on the outside.
- B. Fig. 6, bottom right. Hemispherical bowl of "eggshell" thickness (1.5 mm.) in well purified orange clay with a grey-white slip on the outside. Diam. 13.9 cm., ht. 6 cm. The rim tapers to a point; the base is rounded. Fragments of many such bowls were found. Type: Fernandez de Castro, 'Melilla prehistorica', *Africa*, June, 1936, p. 42.
- C. Bowl diam. 8 cm.; ht. 4.1 cm. with profile curving in sharply towards the rim, which is slightly offset. Refined fabric, orange in colour with a red-brown slip covering the outside and covering the rim to about 1 cm. deep on the inside. The rest of the inside is covered with a deep pink slip and is heavily burnished.

HEMISPHERICAL FOOTED BOWLS, Fig. 7

- D. Fig. 6, centre bottom row. Bowl diam. 11 cm.; base diam. 5.2 cm. The profile curves in gently towards the rim. Thick coarse fabric, deep pink in colour, smoothed on the outside, where there are traces of black paint. There is a slight foot and a ridge below the rim.
- E. Broken bowl about 17.8 cm. diam.; with a ring base of diam. 6.4 cm. The walls thin out to become extremely thin ware, but the rim is thickened. Dark red brown clay with heavy black grits.
- F. Hemispherical bowl diam. 7.3 cm.; ht. 3.8 cm., with off-set moulded foot, and raised interior base. Buff-cream well purified clay with few grits, baked to a dull grey on the outside. The rim is slightly thickened but flat on top. Type: E. Cuadrado 'Cerámica exótica a barniz rojo', *Zephyrus IV*, 1951, p. 280, fig. 5, V. 5 (from Tutugi, Galera).

BOWLS WITH OUT-CURVED RIMS, Fig. 8

- G. Fig. 6, middle row, left. Bowl with incurving rim, diam. 15.5 cm.; ht. 4 cm. Coarse red fabric with dull brownish-red paint disposed in bands on the exterior rim and in three bands on the interior base, forming three concentric circles of increasing width towards the centre. Simple flat foot.
- H. Bowl, diam. 17.5 cm.; ht. 8.8 cm. The rim curves outwards forming an S-profile with the body, and is thickened at the end. The sides of the bowl are thin and delicate and the base is concave with heavy wheel marks on the underside. The fabric is a dusky orange-pink with many small micaceous grits and large pieces of white shell here and there. There is no slip on the exterior, but it is smoothed and wheel-burnished. The top of the rim is painted with a glossy red slip and alternating bands of black and brown decorate the outside. Similar bands on the inside roughly. The base is rough and badly finished. Similar bowls occur at Lixus (unpublished).
- I. Bowl diam. 16.8 cm., ht. 6.2 cm. The general profile is as H but the base is flat and very thin in the centre. Dull orange clay with large white grits. There are no traces of slip or paint. Type: Cintas, *Contribution*, fig. 45, from Mogador.
- J. Fragment of bowl about 12.1 cm. diam. 'S' profile and rim thickened. Grey clay with heavy red slip.
- K. Fig. 6, top right. Well made bowl, diam. 11.9 cm., ht. 4.7 cm.; walls straight but curving inwards to a well-base and outwards to an angular overhanging rim. The base is heavily grooved forming a moulding. The clay is deep covered with a bright red slip heavily burnished on the outside. Type: Bonsor, *CAVB*, fig. 176 where examples of this bowl in "vernis rouge" are said to have come from the Alcázar of Carmona and the upper layers in the Carmona tumuli.

BOWLS WITH ANGULAR PROFILE, Fig. 9

- L. Bowl, diam. 12.5 cm., base diam. 5.9 cm., ht. 5.8 cm. with wall broken by an angle. The base is offset and moulded; the rim is slightly flattened on the interior. The clay is deep pink, well purified and covered with a deeper pink slip. Type: cp. Bonsor, *CAVB*, fig. 177 from the Alcázar at Carmona.

- M. Bowl with S profile, diam. 7.7 cm., base 4.2 cm., ht. 5.1 cm. Pedestal base with slightly moulded foot. Dull brown clay with black slip with traces of brown wash on the exterior. Type: Cuadrado *op. cit.*, p. 278, fig. 4, IV, 1.
- N. Fragments of a vessel of sharp profile and outward turning, diam. 15.9 cm., base diam. 5 cm. The base is flat and irregular on the inside. Dull grey clay baked to an orange brown on the exterior and covered with a plum-red wash before firing. The profile is similar to examples Cuadrado *op. cit.*, fig. 3, type III.
- O. Well made bowl, 18 cm. in diam., ht. 31. cm., base missing. The upper half above the body angle has a subtle curve and the rim is angular. The base is broken in such a way as to suggest that the piece was originally the upper part of a 'lampe à soucoupe'. The clay is creamy pink and well refined but with minute micaceous grits. The exterior is covered with a bright red slip and heavily wheel-burnished to make a varnish-like surface. Type: Cintas, *Contribution*, p. 50 and fig. 53 which is identical in profile; E. Cuadrado, *op. cit.*, type B6.

SHALLOW DISHES AND PLATES, Fig. 10

- P. Fig. 6, central. Dish diam. 17.7 cm., straight sides with walls tapering towards a turned-over rim. Cushion foot with a well on the inside. The well is gracefully set off from the walls and has a small rising in the centre. Type: Cuadrado, *op. cit.*, fig. 10.
- Q. Fig. 1, middle right. Dish diam. 15.8 cm., ht. 3.1 cm. with walls tapering towards the rim, which is flattened on the end and slightly bulbous. The interior base is inset forming a well and the exterior base is flat. Heavy wheel marks on the exterior. The clay is light brown, very cellular and the interior is covered with a thick red shiny glaze which is flaky and gives the appearance of enamel.
- R. Fragment of shallow dish originally 14 cm. diam. Red clay, imperfectly oxidised in the middle and forming a sandwich effect in section. Both sides of the fragment are covered with a heavy brick red slip.
- S. Fragmentary shallow dish in rough, orange clay. Original diam. ca. 15 cm. Pedestal foot. cp. Cintas, *Contribution* fig. 52, third from top. Type: E. Cuadrado, *op. cit.*, fig 11.
- T. Shallow dish diam. 18.1 cm.; base diam. 6.1 cm., ht. 4.3 cm. Cushion foot, well base with central omphalos. The

walls are slightly convex and the rim is turned outwards. Uniform rough dull grey clay smoothed on the outside.

- U. Fig. 6, top left. Shallow plate diam. 18.2 cm., ht. 4.2 cm., with sides flattening gently towards the rim. The base is set deeper from the end of the walls, forming a shallow well. The outside of the base has a heavy groove in it. The clay is dull red and full of impurities. There is a pale brown slip or wash on which are applied before firing concentric bands of dull red wash on the inside.
- V. Shallow plate diam. 17.3 cm., base diam. 3.9 cm., ht. 6.5 cm. Walls thin, slightly convex. Base flat, slightly offset in the interior wall. Dull red clay with heavy wheel marks on the outer surface. No slip or polish.

These two last examples are common forms of fifth-sixth century Punic plates. Cp. Cintas, *Contribution*, fig. 52, and *CP*, No. 166.

OTHER VESSELS, Fig. 10

- W. Lower part of a globular vessel or jug, surviving, ht. 19.4 cm. Clay bright orange with small yellow grits. There are heavy wheel marks on the interior.
- X. Piece of the neck of an urn of Punic type: Cintas, *CP* No. 116. The attachment of a handle of figure-8 section can be seen. This urn has been found in Mogador, Cintas, *Contribution*, fig. 51, and Rachgoun, Vuillemot, *Reconnaissances*, p. 66, fig. 21. Generally it went out of use in the early sixth century, but this crude specimen in rough orange clay may be a later survival.
- Y. Not drawn: single beaked lamp, diam. 7.2 cm. of normal Punic type but without the flat border found in other examples found in Spain, especially at Carmona cp. Bonsar, *CAVB*, fig. 73. Lamps of this type are common in Ibiza, where the *lampe à rebord* does not seem to have been used. The clay is dull red with a dull grey patina. Fig. 6 bottom row.

It only remains to mention a few sherds of interest. There are two sherds of bright orange refined clay with micaceous grits which appear to be part of the walls of a globular vessel; there is a bright red wash on both sides of the vessel. These are the only sherds in the find which appear to be genuinely Carthaginian in fabric, and compare with fabrics at Carthage of the fifth century. A further piece which is reminiscent of the pottery of Carthage is a large sherd of pale grey fabric baked to a dusky pink on the

exterior and having evidently belonged to a large shallow basin. It is decorated on both sides with thin black painted lines widely spaced. There are in addition a few sherds of a thick (0.75 cm.) brownish pink ware, well baked and of the same consistency throughout. There is a deep cream slip; on the outside a painted decoration consisting of closely grouped thin black lines set at right angles to a horizontal thick black stripe.

The discussion on the types and date-range of the red-slip wares of Southern Spain has been most recently recapitulated by M. Tarradell, 'La cerámica pre-romana de barniz rojo', *Hesperis-Tamuda* I, 1960, pp. 235-52, who has concluded that the ware is not as homogeneous as was once supposed. Earliest appears to be a ware of heavy red slip of a rather dark colour: the slip appears 'alisado con espátula', but in texture and colour this group is not uniform. Tarradell proposes that this ware is directly descended from the red-slip ware of Cyprus.

At Lixus ware of this heavy red-slip type appears in the lowest levels: also at Mogador, Almunécar, and in the jug from Torre del Mar it appears to be early seventh-sixth century, B.C., whereas it is not found amongst the red-slip material coming from Iberian-ware contexts of the fifth century B.C. and later.

A second type of red-slip is distinguished by its soapy feeling, bright red unburnished slip, applied in horizontal striations, probably on the wheel. 'La capa de color es muy delgada y ilegala diluirse en el agua si se sumerge durante cierto tempo.' It appears in quantity in Lixus and Mogador and appears to be a local and inferior imitation of the first type.

The third type is strictly a red-washed or painted ware, in which the paint or wash is thin and irregular. That this type is a late product is shown by its occurrence with Campanian Ware A in Lixus. It appears commonly in Iberian sites in coastal regions. When Cuadrado published his distribution map of Spanish red wares in 1953, almost all occurrences were from Iberian graveyards containing material of the fourth-third centuries B.C. Its absence from the sphere of Phoenician influence in Andalusia led Cuadrado to propose an origin in the Greek sphere of influence on the Valencian coast.

The earlier stages of the ware have been well defined in *Toscanos*, p. 82 ff. The illustrated colour texture of pl. 7, 311 corresponds closely to that of O, and pl. 7, 164 and 305 correspond closely to O in both the light beige clay tone and slip texture. The association of whitish or yellowish well purified clay with burnished red slip is also found on sherds from the lowest level (stratum 4) at Aljaraque, J. M. Blázquez *et al.*, 'La Factoria púnica Aljaraque en la Provincia de Huelva' *Noticario Arqueológico Hispanico*,

XIII-XIV, Madrid 1971. Red-slip wares excavated by G. Bonsor at Carmona (now in the Hispanic Society of America, New York) also have a yellowish white clay, though the clay of larger vessels such as A. F. Avilés', 'Vaso Oriental de Torre del Mar, Malaga, *Arq. e Hist.*, 8, 1958, pp. 39-42, has reddish fabric.

The plates L, M do not correspond in shape to any of the wide selection of red-slipped plates from Toscanos; their well-centres and carefully made feet suggest a later stage of Punic pottery and the thick dark red slip of M, which has a slight oily feel, suggests comparison with Tarradell's second group.

The fabric of H appears related to the local Iron Age wares found by Droop in his excavations at Niebla in the province of Huelva—*Liverpool Annals of Anthropology and Archaeology*, XII, 1925, p. 175 f. Sherds are described as belonging to vases of fair size and of fine hard baked clay, pale pink in colour often given a buff surface. A few of the pieces show painted decoration in matt red in horizontal lines and bands. These bands are sometimes burnished and a few of the sherds show a certain amount of burnishing all over. Thin lines in black and brown alongside the red—device derived from Punic pottery—are also used. Sherds illustrated by Droop, pl. XXXVe show parts of a bowl with offset rim very similar to G.

A. Guerrero gives photographs but no detailed commentary of Ibero-Punic material found stratified above primitive hand-made wares on the site of Mesas de Asta (Roman Asta Regia near Jerez (*Informes y Memorias*, etc., Vol. 22). This material is early fourth century B.C. at the earliest, to judge from two Punic urn types of the third century which were apparently stratified above it (*ibid.* pl. XV) and contains shallow dishes which correspond in shape and burnish to B and Q from Gorham's cave, and plates with well-centres, slope-sided dishes with narrow base, and shallow dishes with incurving rims, like G. Bands of burnished red paint decorate the insides of the plates in a manner characteristic of Gorham's cave material, Guerrero. *loc. cit.*, pl. IX. A globular amphora in the same ware as some of the Punic plates (pl. IX fig. 2) is of characteristically Iberian shape and corresponds to some of the jar-shapes of Cuadrado's (i.e. late) *barniz rojo* ware. The actual stratigraphic position of this Ibero-Punic material is not given in the report, but a certain amount of late fourth century B.C. Greek pottery and later Campanian was apparently mixed in with it.

Footed bowls with concentric lines of paint (G) are peculiar to the southern and eastern facies of Iberian pottery and occur in areas where Punic influence was strong. Usually, however, con-

centric semi-circles and parallel tremolo lines in the Iberian manner enhance the simple linear decoration. Examples are the bowl from the Necropolis of S. Antoni, Oriola, *Colleccio de Treballs del P. J. Furgus* (Valencia 1937), p. 9, fig. 4a, and bowls from a context containing Campanian and Punic pottery on the Isleta del Campello, Alicante, *Archivo Espanol de Arqueologia* XXVIII, 1955, fig 15, which have simple linear decoration like the Gibraltar bowls. From the Guadiana valley, a bowl from Hinojares, C. Fernandez Chicarro, *Boletin del Instituto de Estudios Giennenses* II num. 6, fig. 4, is near in shape to G.

The plates are of general Punic type, not included in CP, though the well-centre plate is common in Punic pottery from 500 B.C. onwards. U and V compare closely with plates from level 3 at Cabezo de San Pedro (fourth-third century) Blázquez, *loc. cit.*, pl. V.

Hemispherical bowls of "eggshell" ware (Fig. B), of which numerous fragments are found amongst the material, are of a retarded type originating perhaps at Al Mina in Northern Syria in the 8th c., and occurring in graves in Cyprus at Larnaka and Amathus. They are common on Motya from the eighth to the sixth century but are not found at Carthage, Utica, Sardinia or Ibiza. The red or orange coloured wash on the upper halves of the bowls is characteristic. At a later period these bowls are characteristic of small North African trading stations. They occur at Sabratha in the 3rd. The nearest—both geographically and typologically to those at Gibraltar, are bowls in a third century B.C. context at Melilla. But these bowls had a long life, and it is not possible to tie them down chronologically.

Fig. 11 illustrates a selection of plain ware dishes in the British Museum from Gorham's cave. Fig 12a is a juglet, 4½ inches high in plain orange-brown ware with white grits and handle consisting of a double cordon. This is a well-known Phoenician potting technique, though the precise shape is not recorded among Punic pottery. There is no doubt that the heavy clean-cut flat base is typically Punic, and it is very probable that it is a close relative of the 'oenoché à bouche rond' of the Ard el-Kheraib graves at Carthage, A. Merlin, A. Drappier, *La nécropole punique d'Ard el-Kheraib*, pl. 4, 10.

Two other juglets are known to me from Gorham's cave, though I have seen neither. Fig. 12b, is an olpe (height 5.4 ins.) with biconical body, and unusually featured handle, reminiscent of a vessel said to be Ionic from grave Martí 83 at Ampurias (Almagro *op. cit.*, I). A closely related form is Merlin and Drappier *op. cit.* no. 31 of the fourth century B.C. Fig. 12c (4½ ins. high)

has a double-cordon handle, but is of shape without parallel in western pottery either Greek or Punic.

HANDMADE POTTERY, Fig. 13

Along with the Punic pottery, which for the most part is wheel-made, and has that appearance of mass production characteristic of all Punic pottery, sherds of an entirely different kind, which were found mixed with it in the upper stratum of the cave, should be noted. Those formerly in the Ashmolean are illustrated in fig. 13:

- a. Rim fragment of a jar in blackish-brown pottery of flaky texture containing minute particles of shell. There are three semi-circular-sectioned channelled grooves below the rim and a series of cleanly-cut triangular stabs below. The outside of the sherd is smooth and the inside of the vessel was covered with a dull red wash applied before baking.
- b. Rim fragment of a barrel-shaped jar in grey-black, flaky with small black grits, well smoothed on both sides. There are four shallow channelled grooves below the rim.
- c. Rim sherd of an open bowl with ledge outside the rim. The underside of this ledge bears hemispherical indentations, which appear to have been made with a stick. The body immediately below the ridge is wavy in section, each channel being demarcated by a good grooved line. Grey brown paste-like clay, baked to a hard chocolate brown exterior.
- d. Rim fragment of a small pot with vertical lug handle, flaky grey-brown clay.
- e. Rim fragment of an open vessel in soft brown well purified clay with cleanly cut notches in the rim. Both sides of the vessel are baked lighter brown and polished.
- f. Rim of a jar-like vessel, thick and turned outwards. Series of parallel scratch marks on the outside. Rough grey-brown friable clay.
- g. Rim fragment of an open vessel of a soft-grey well purified clay. There is a small groove on the outside-top of the rim, and below three rows of comma-like slightly oblique stabs. The sherd is heavily burnished on both sides.

- h. Rim profiles of small coarse friable sherds in dull grey and brown pottery. The clay is identical with that of the above sherds.
- i. Clay spoon (drawn half-size). Dark grey friable fabric baked dull pink on the outside. The surface is wet-smoothed to form a firm dull pink coating.

In a number of recently excavated sites in southern Spain as well as at Mersa Madakh, near Oran, hand-made wares have appeared in strata containing Punic wares of the seventh-sixth centuries B.C.: J. M. Blázquez *et al.* *Huelva Arqueológica, Las Cerámicas del Cabezo de San Pedro* Huelva 1970. *Toscanos* 206 and 1242 compare with *b.* and *d.* It appears that there was a period of overlap between the local vessels of Late Bronze Age tradition and the imported Punic tradition of pottery making.

The shapes of *a*, *c*, *e* more closely resemble the beaker shapes from Mersa Madakh, Vuillemot *Reconnaisances*, fig. 52, than the enclosed amphora shapes from *Toscanos* and *Huelva*. The closest parallels known to me to the Gorham's cave sherds come from the channelled wares of the Paralli graves at Ampurias, M. Almagro, *Las Necrópolis de Ampurias*, II, 1955, pp. 337-356, where both the decorative techniques and exotic rim profiles are paralleled on vessels belonging to a graveyard dating to immediately before the time of the Greek founding of Emporion (i.e. about 500 B.C.). The comparative position of this necropolis in relation to the Catalanian and southern French sequence is discussed by W. Schüle, 'Probleme der Eisenzeit auf der iberischen Halbinsel', *Jahrb. Röm.-Germ. Mus. Mainz*, 7, 1960, p. 69. Sherds from Cortes de Navarra IIa, *ibid.*, fig. 17, D 13 and 19 are identical, with *a* and *c* and serve to confirm the impression that the Gorham's cave sherds are southern offshoots of the Ebro-Catalonian region in the seventh-sixth centuries B.C.

TERRACOTTAS, GLASS, FIBULAE Fig. 14

The finds include two fragments of terracotta figures (fig. 14 a, b). The latter is part of a man's head. He wears a close-fitting head-dress with an incised design on the front. Compare the head-dress worn by the man depicted on the razor, R. P. Delattre, 'Nécropole punique voisine de Sainte-Monique, deuxième trimestre de fouilles', *Cosmos*, Paris 1900, fig. 60. Between the termination of the head-dress and the face is a headband, dipping over the temples and terminating behind the ears—a type peculiar to Carthage. The fabric is refined pale orange clay similar to that of Ibiza, where terracottas in a generally similar Phoenician style have been found, cp. A. Vives, *op. cit.*, pl. XXIX.

In identical clay but belonging to the Greek-style of Ibizan terracottas are two parts of a female head, hollow at the back and rounded at the edges, probably part of a funerary mask or protome. It was made in a mould and the imprint of the knuckles are to be seen on the back. Though undoubtedly manufactured on Punic sites, these masks are copied from the Rhodian-type busts of Aphrodite which are commonly met with in Sicily, particularly at the Rhodian colony of Gela. Hence the features of most examples are Greek rather than Semitic in type. Their use is quite unknown. Cp. Roman y Calvet, *Las nombres ed importancia arqueologica de las Islas Pityussas*, Barcelona 1907, pl. LXI.

There are fragments of three small amphoriskoi, Fig. 14 *c-e* of ultramarine blue glass. Round the body is a chevron pattern of drawn strands of yellow and white glass and a yellow strand of yellow glass is worked into the handle of example *c*. Horizontal bands of yellow or white demarcate the chevron zone. Fragments were also found on a juglet (foot missing) (*f*) in the same technique. Both shapes are common in glassware of Punic sites from the fifth to the third centuries B.C. and Ibiza has furnished a large number of identical shapes and patterns: Vives, *op. cit.*, pl. XX. Probably the numerous examples found in the graves of the Greek settlement at Ampurias, M. Almagro, *Las Necrópolis de Ampurias*, I, 1953, pl. VI came from Ibiza. The friable glass of the Gibraltar examples is much inferior to that of earlier oriental imports, e.g., at Cumae, Gabrici, Cuma, *MA*, XXIII, col. 158. The form copies that of a Greek amphora current in the late sixth century B.C. A specimen from Alicante of identical amphoriskos form is the nearest piece of glass geographically and is well dated in an early fourth century context, Lafuente Vidal, *Esquema de la Necrópolis de Alicante*, Madrid, 1949, p. 18. Beyond Gibraltar, parts of glass vessels of this type have been found at Lixus (unpublished) and from the Hallstatt site of Alcacer-do-Sal in Portugal.

There are in addition a number of beads of thick dark opaque blue glass which, unlike the majority of Carthaginian glass beads, do not have inlaid "eyes" of white glass or paste but are of a texture and density similar to glass beads from Al Mina in Northern Syria. Similar beads from Fonte Velha da Bensafrim, Southern Portugal, are illustrated by S. P. M. Estacio da Veiga, *Antiguidades Monumentaes do Algarve*, Lisbon 1889, pl. XXVIII. They were traded by the Western Phoenicians along the coasts of Portugal and even into Galicia, L. Cuevillas, *La civilización celtica en Galicia*, pp. 178 ff, 302.

Fragments of metal are of fish-hooks (*i*) and of two La Tène I type brooches of bronze (*g*, *h*). Fish-hooks are common on Punic sites as well as fish forks and spears, for the livelihood of such isolated settlements as Gibraltar must have depended largely on the sea. The presence of the brooches is interesting, for the Carthaginians used straight pins and had no kind of catch-pin; their clothes appear to have been tailored and fairly close fitting. The brooches have bulbous ends bent back upon the bow and are of a type peculiar to South-western France and the Iberian Peninsula where their appearance in dated contexts indicates that they are predominantly of the fourth century B.C. This fibula type, which might be of Hallstatt origin, is common in Catalonia and Castille. I know of no dated Castillian contexts; in Catalonia the grave groups at Ampurias, Almagro, *Ampurias I and II passim* show that it appeared there after the fifth century and is mainly third-fourth century. Dated contexts occur in Southern France; Louis and Tuffanel, *Le premier Age du Fer languédocien* part I, p. 124, fig. 101 and fig. 105 from Cayla de Mailhac, in one example occurring with a fourth century coin of Motya; *ibid.*, part II, p. 183 (Ensérune) and Jannoray *Ensérune* p. 392 ff. A few of these examples have precisely the same bulbous ends as the Gibraltar ones.

CONCLUSION

It would be surprising if the Carthaginians had not occupied Gibraltar at some time. The closing of the Straits to Greek shipping after the battle of Alalia in 535 B.C. makes it a virtual certainty. The natural fortress provided by the rock itself and the safe anchorage in the Bay of Algeciras on its western side, together with the necessity of protecting the Punic cities of Tamuda and Lixus on the opposite shore—these are all factors which might be expected to have given rise to a fortification and settlement. Yet ancient geographers and historians make no mention of either Carthaginian town or fort. Calpe, its name in Greek geography, is most likely of Iberian origin (cf. the nearby 'Cilbici' of Avienus' *Ora* v. 303). In fact Strabo Bk. 3, 1, 7, quoting Artemidorus, says that it was a small fortress of the Bastetani Iberians and that the 'city of Calpe' was near it. Quoting Timosthenes, Strabo states that Calpe (or Heracleia) was an Iberian naval station. He therefore appears to conflate Calpe and Heracleia.

'Calpe' in Pomponius Mela (II, 96), Ptolemy (II, 4) and Marcian (II, 9) is used in a context which implies a town and the *Antonine Itinerary* 406 (as well as the *Cosmography* of Honorius,

Geographi Latini Minores, p. 34) refer to *Calpis oppidum*. Even so, there is no Roman coinage of Calpe.

A possibility is that in both Punic and Roman times Calpe was an appendage of Carteia ten miles to the west at the mouth of the R. Guadarranque near El Rocadillo. Strabo III, I, 7 quotes Timosthenes on the high antiquity of Carteia and its shipyards. The 'Qart' element could also be taken as evidence of a Punic or Phoenician origin. Strabo's alternative name 'Heracleia' is further suggestive that a cult of Melqart existed there. But how early? According to Silius Italicus, Hamilcar Barca passed by Carteia and Calpe in order to subdue the Tartessians—but he may be making use of contemporary geography; and in any case it is poetry. We must not, however, overlook the possibility that a Phoenician station existed at the Guadarranque mouth. Carteia had a Roman coinage in the second century, and extensive Roman ruins are located there as well as at Baelo, north of La Linea.

The pottery from Gorham's Cave provides important evidence for Punic presence on Gibraltar before the Punic wars. Bearing in mind that the deposit does not appear to belong to 'occupation' or to burials, a religious explanation is the most likely. Offerings to the genius loci, as in the Cueva de Es Cuyram in Ibiza, would account for the terracottas, seals, trinkets and food dishes. Important circumstantial evidence that Punic cults existed in the entrance to the Straits is provided by verse 350 of Festus Avienus' *Ora Marittima*, where he states (using Euktemon) that altars to Hercules had been erected on two small islands near Calpe. A. Schulten (in O. Jessen, *Die Strasse von Gibraltar*, Berlin 1927, p. 183, follows V. Bérard in *Les Phéniciens et l'Odysée II*, p. 264 ff., in suggesting that these islands are Peregil on the African side and Palomas east of Tarifa (off Punta Carnero) at the western entrance of Algeciras Bay. Whilst their position and nature does not satisfy Euktemon's description—they are neither wooded nor thirty stades apart—the text does appear to retain genuine memory of certain conditions under which Greek sailors were allowed brief access to these shrines at a time of Carthaginian restrictions. Perhaps they were on islands now covered by changes of sea level: at least there *was* cult at the Straits in addition to the better-attested cult of the Pillars of Hercules at Cadiz. The Gorham's Cave remains might be connected with it.

Lack of permanent water sources on the Rock and the low marshy land which severed it from the hinterland would discourage permanent settlers. Its natural use to mankind was as a seasonal fishing pier or as a fowling station when the inland waters of the Laguna de la Janda attracted migratory birds.

NOTE:

The bowls in the British Museum illustrated in Fig. 11 are: *a*, 132399, flaring bowl heavily restored. Salmon pink refined clay, mechanically smoothed. *b*, 133001, small interned bowl of well-fired buff ware. *c*, 133000 well-centre plate of refined well-fired buff ware with scattered black grits. *d*, 133003, thin ware bowl with ring base well-fired buff ware with paler slip inside and out. The lower half of the bowl was painted red. *e*, 133005, shallow plate with groove beneath inside rim. Buff clay wet-smoothed. *f*, 133002, footed bowl of buff ware with charcoal grey burnished slip. The jug Fig. 12 *a*, 13300, is of refined orange-buff clay, with a flat handle with a slight groove in the back.

All objects formerly in the Ashmolean Museum have now been returned to the Gibraltar Museum. The Ashmolean retains an official record of the scarabs noted above.

ABBREVIATIONS:

Bonsor, <i>CAVB</i>	George Bonsor, 'Colonies agricoles préromaines de la vallée du Betis', <i>Revue archéologique</i> , 1899, 2, p. 126 ff.
Cintas, <i>CP</i>	Pierre Cintas, <i>Céramique punique</i> , Paris, 1950.
Cintas, <i>Contribution</i>	Pierre Cintas, <i>Contribution à l'étude de l'expansion carthaginoise au Maroc</i> , Paris, 1954.
<i>Toscanos</i>	H. G. Niemeyer and H. Schubart, <i>Toscanos 1964</i> (Madriider Forschungen 6), 1969.
Vuillemot, <i>Reconnaissances</i>	G. Vuillemot, <i>Reconnaissances aux échelles puniques d'Oranie</i> , Autun, 1965.

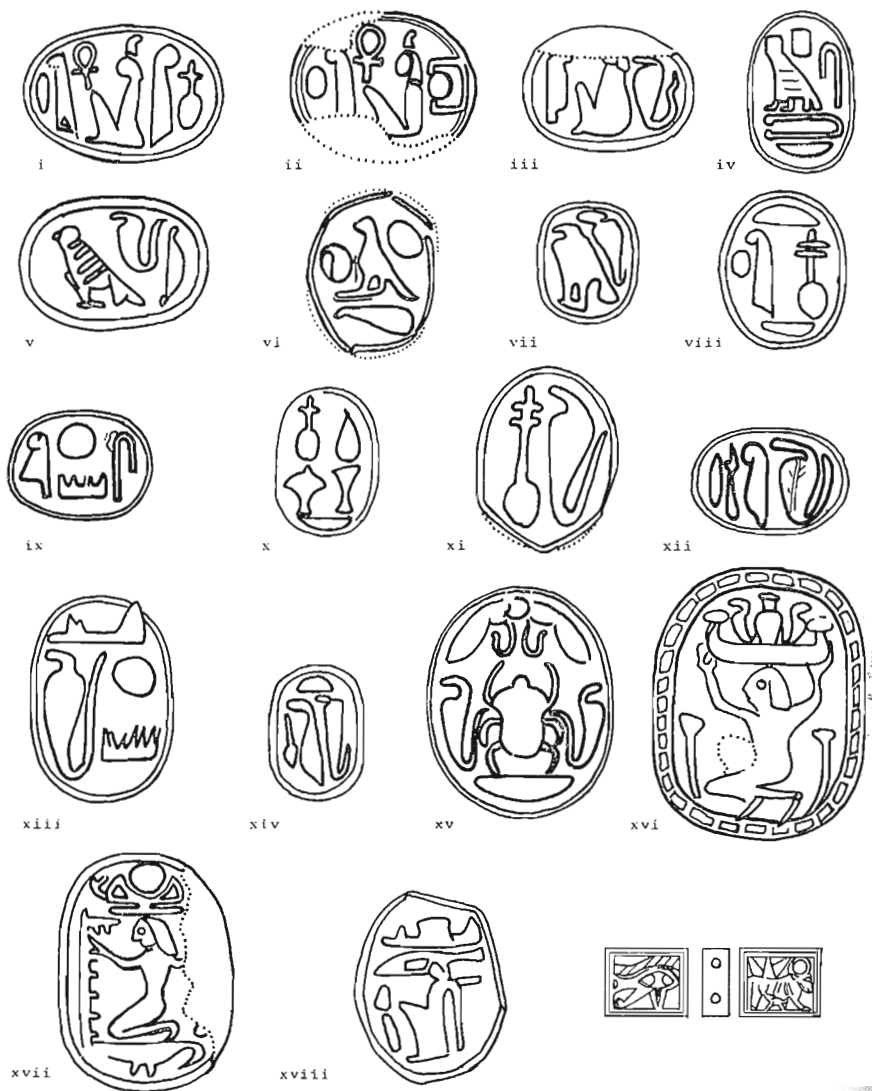

FIG. 1

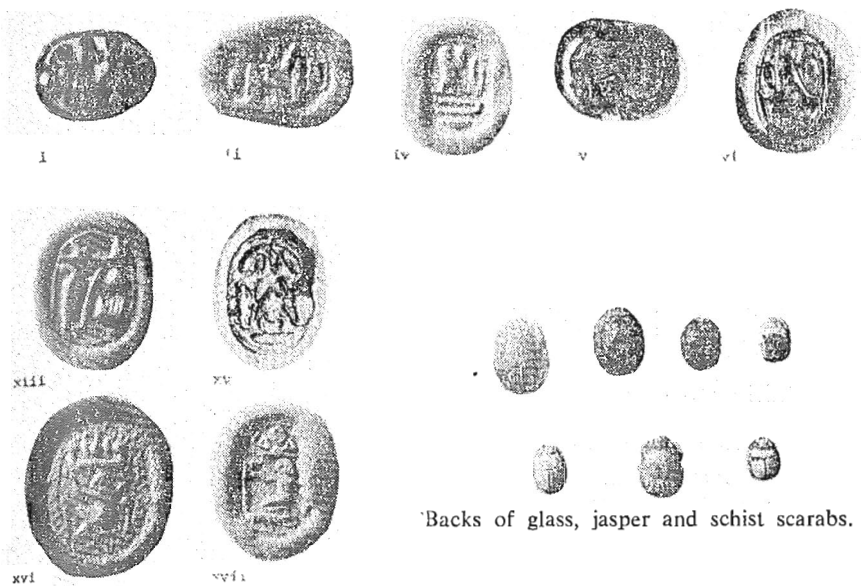

FIG. 2

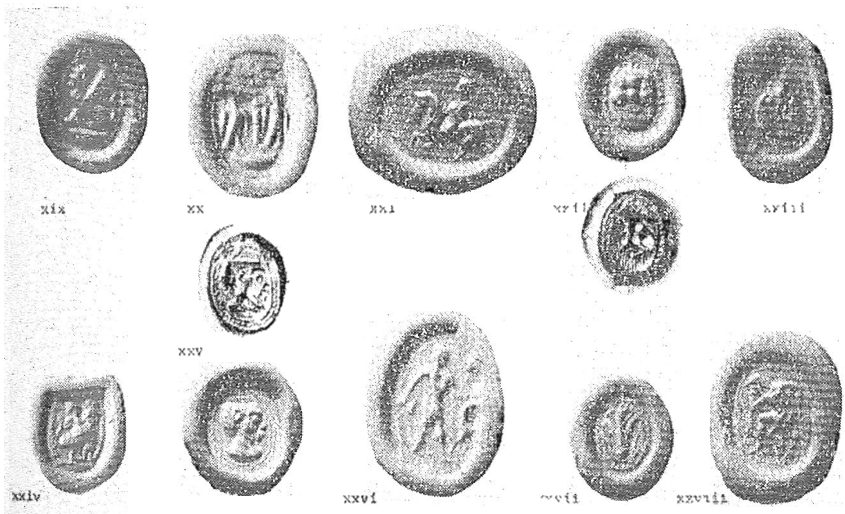
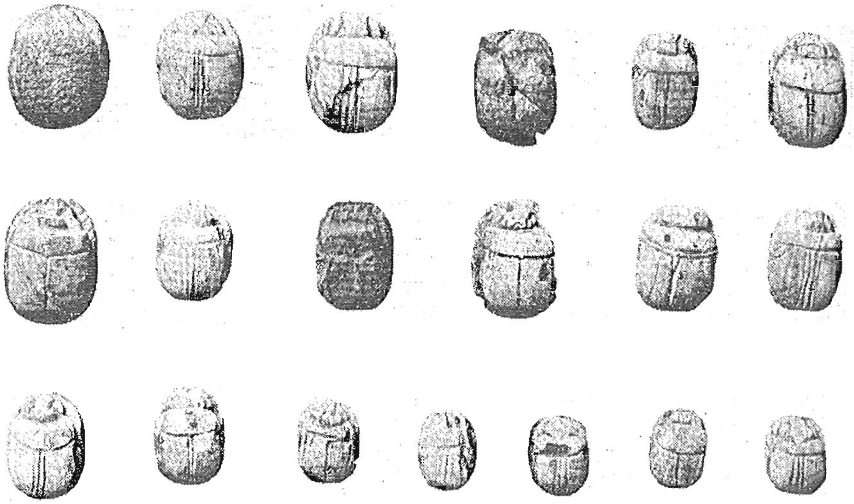
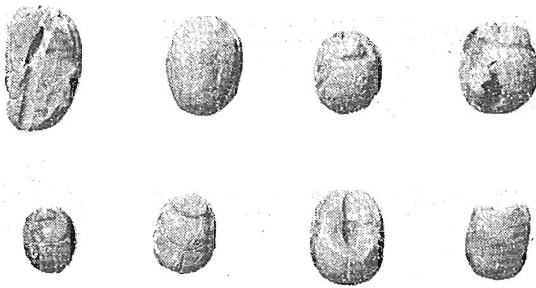

FIG. 3



Backs of paste.

FIG. 4



Backs of jasper scarabs

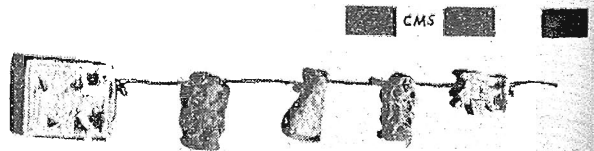

Amulets from Gorham's Cave, Gibraltar Museum

FIG. 5

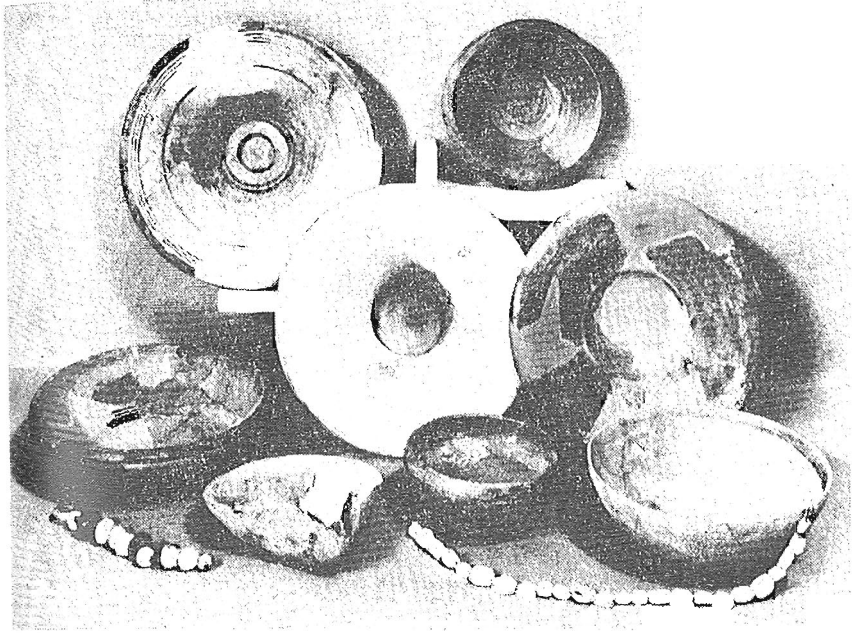
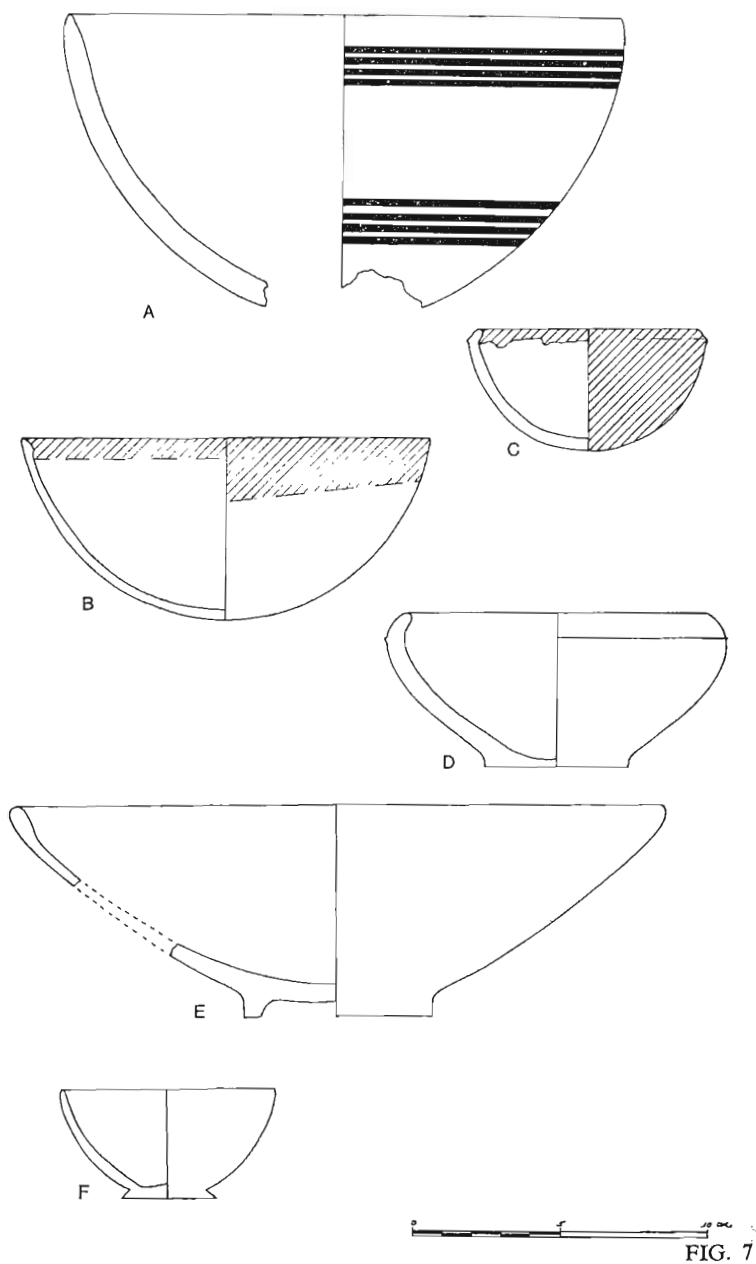
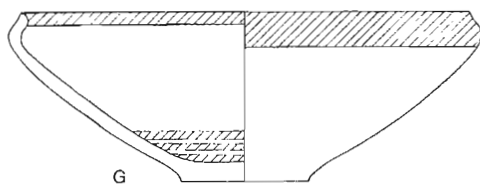

FIG. 6

Pottery, beads and scarabs as formerly displayed in the Ashmolean Museum.





G

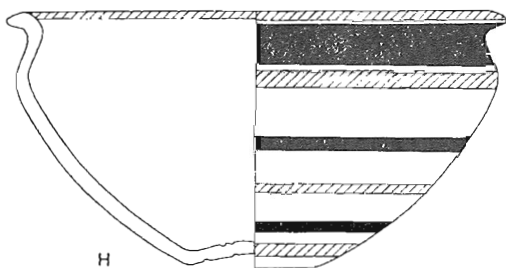

H

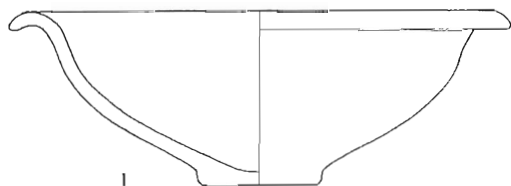

I

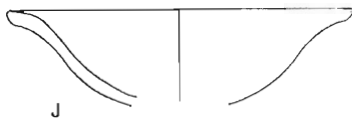

J

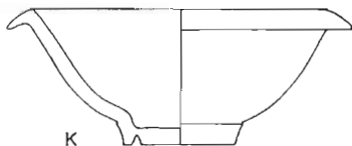

K



FIG. 8

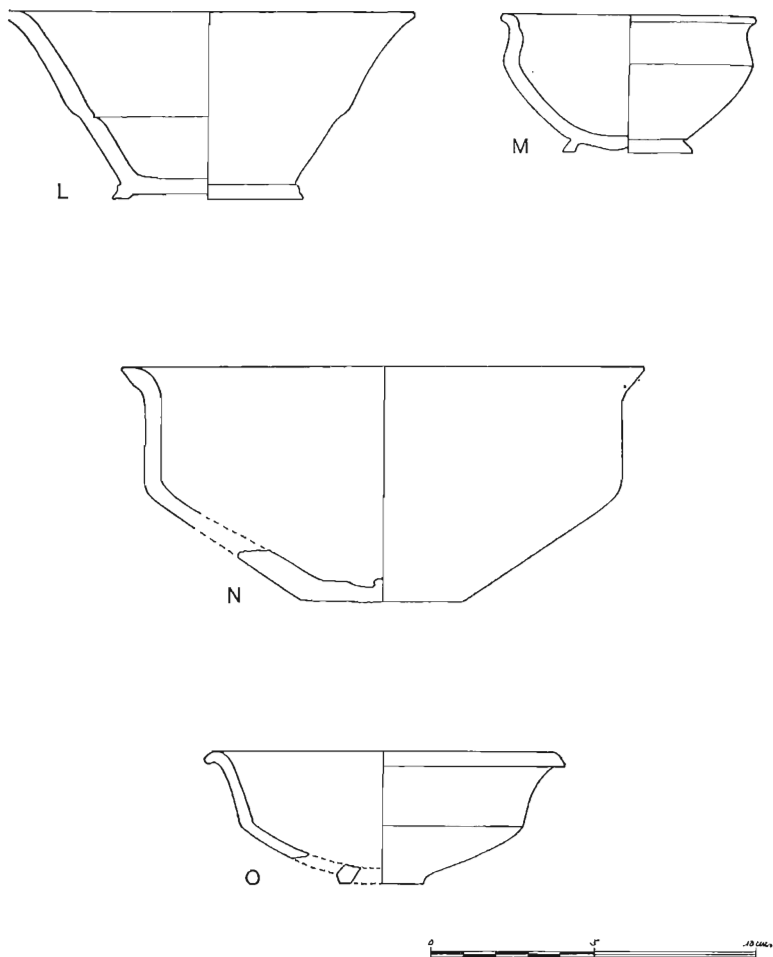

FIG. 9

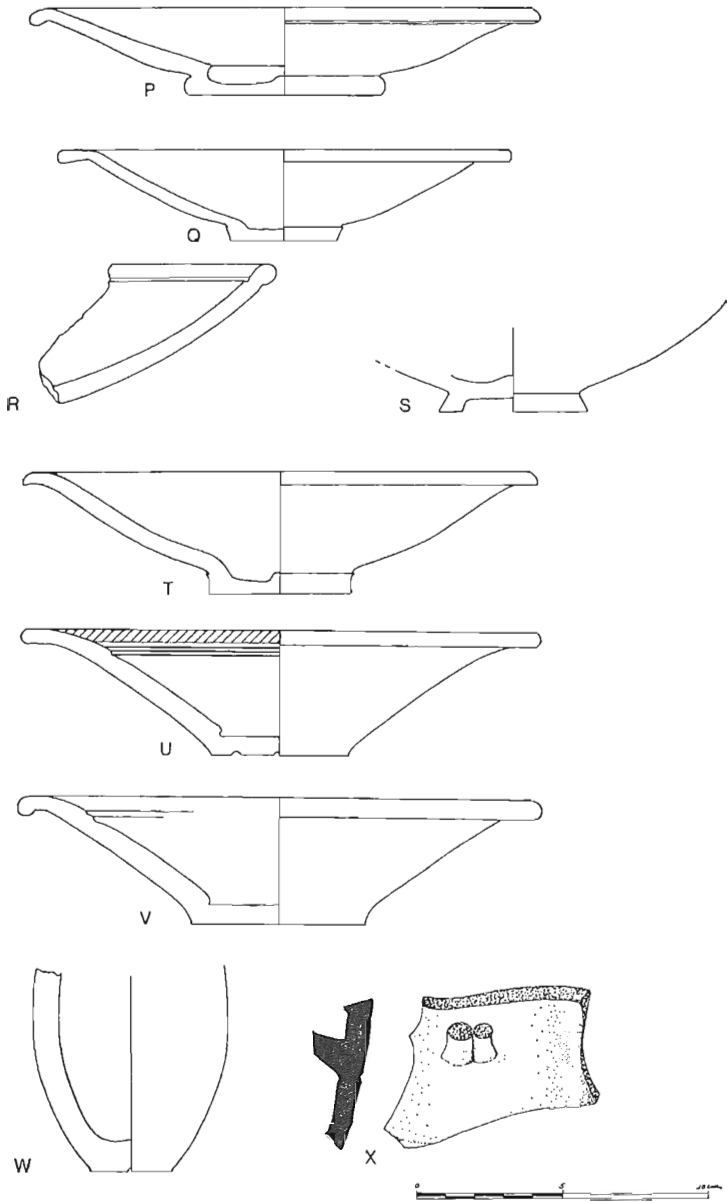

FIG. 10

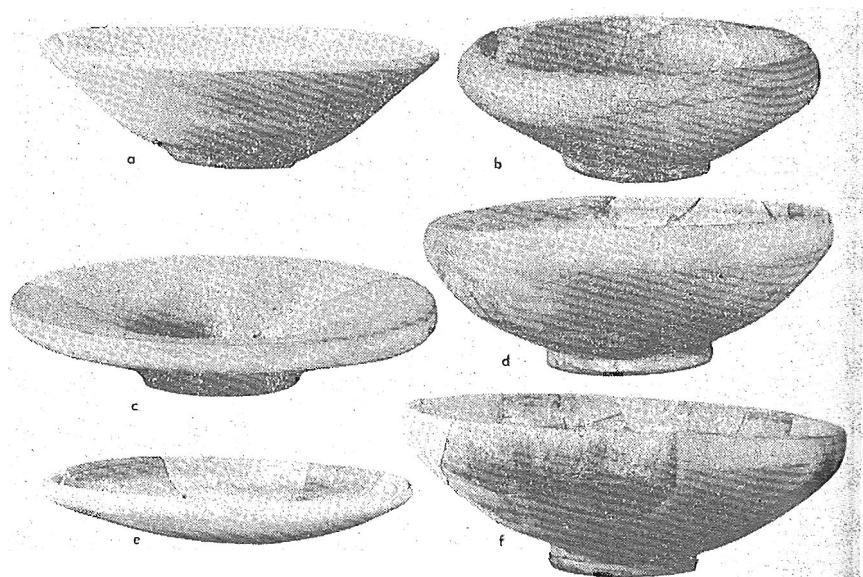
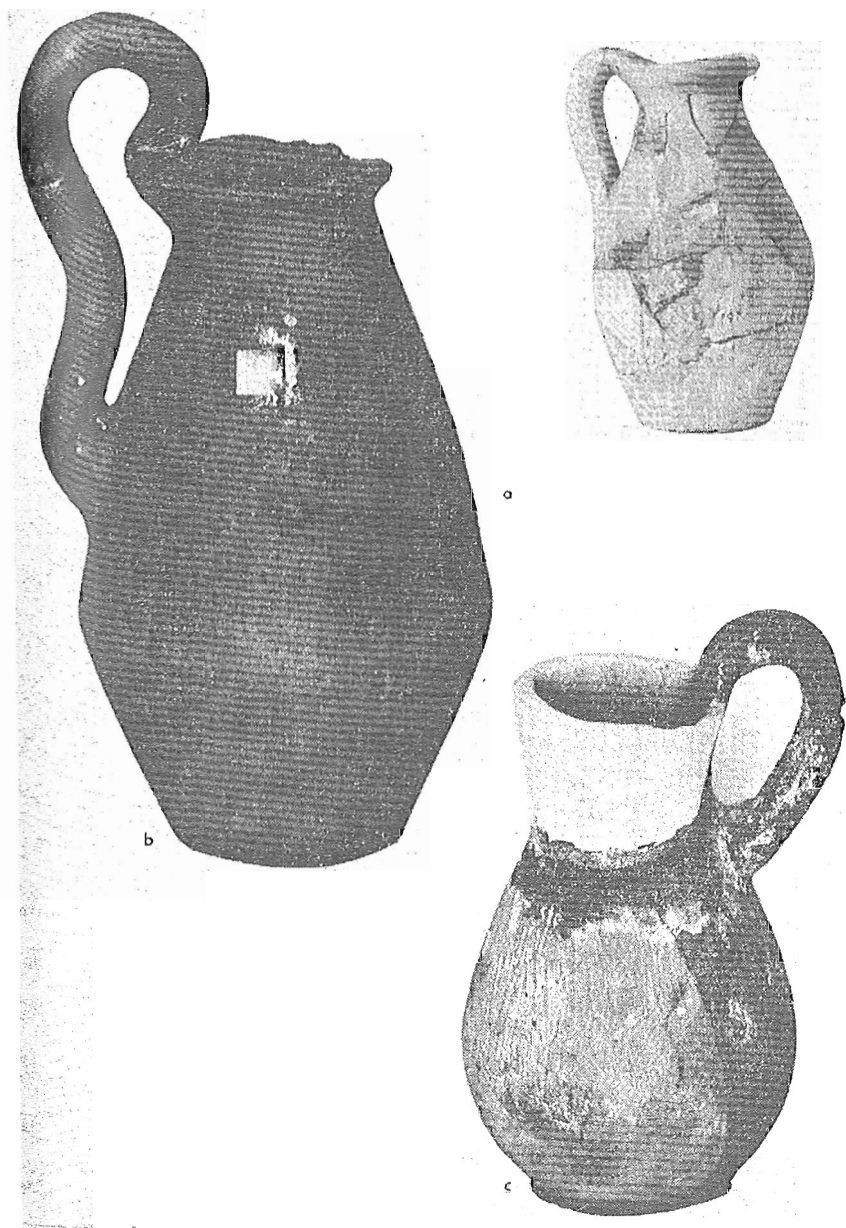

FIG. 11

Plain Ware bowls from Gorham's Cave in the British Museum. Rim diameters are:
a. 21 cm; b. 9.4 cm; c. 18.1 cm; d. 15.8 cm; e. 12.2 cm; f. 16 cm.



Plain Ware jugs from Gorham's Cave:
a. British Museum. b.-c. Gibraltar Museum.

FIG. 12

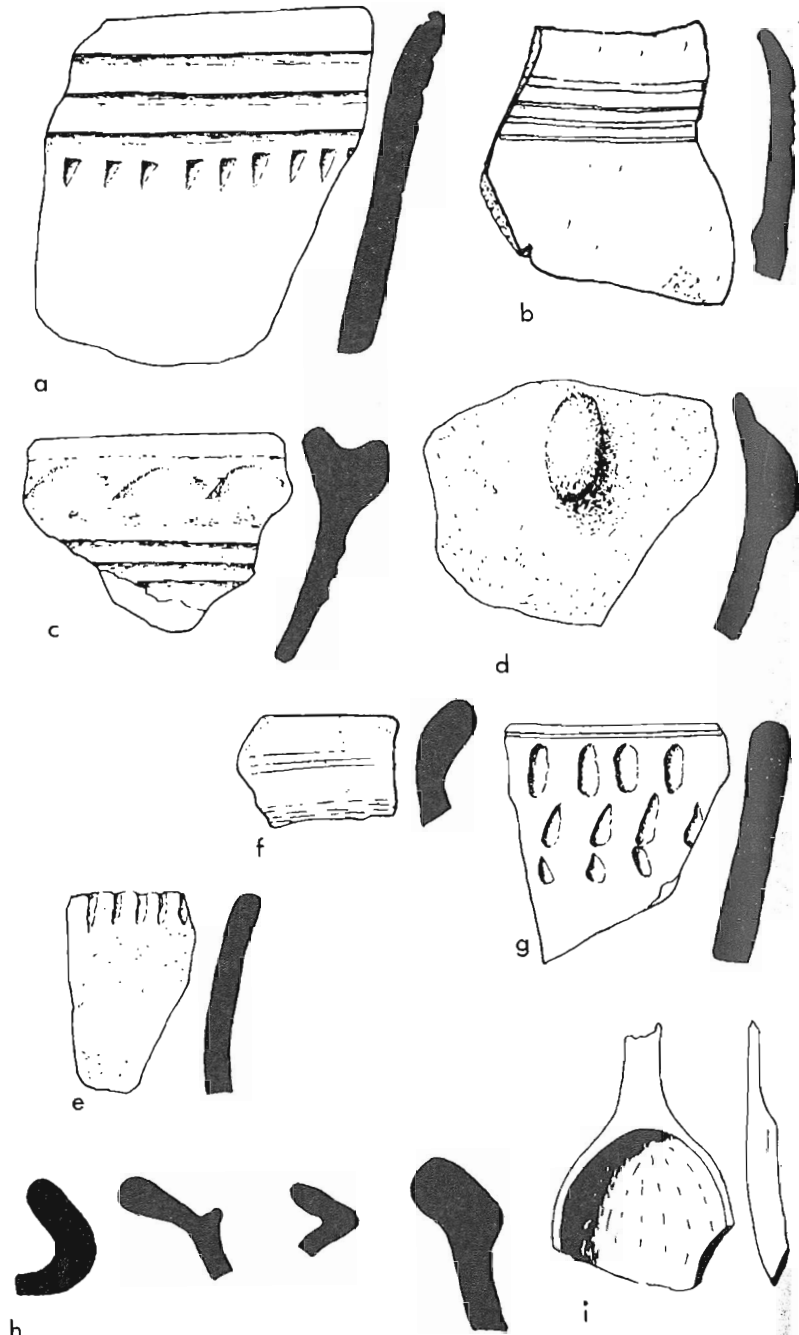

Handmade pottery.

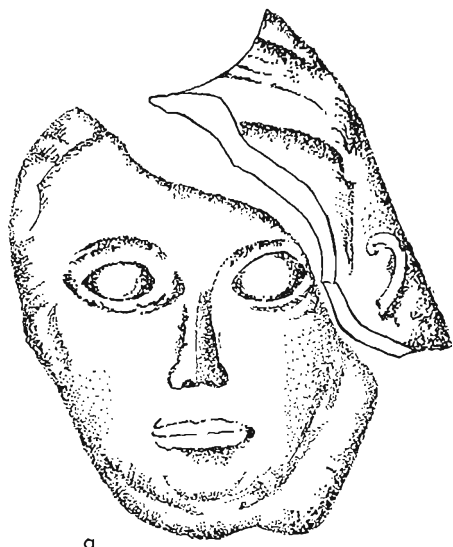

a



b



c



d

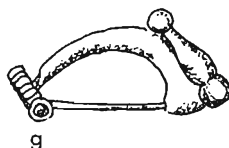

g



h



f

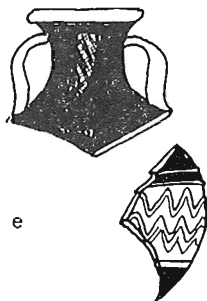

e



i

Terracottas, glasses and bronzes.